

N.01/2021

dal 1950

forplas
materiali plastici

FCA

DISTRIBUZIONE

FLOORINGS - COVERINGS - ACCESSORIES

SOMMARIO

PAVIMENTI VINILICI	1-2-3-4-5
PAVIMENTI SPORTIVI	6
PAVIMENTI IN GOMMA	6
PROFILI IN PVC	7-8-9-10-11-12-13
PROFILI IN METALLO	14-15-16
PASSATOIE TESSILI	17
COLLANTI E ADDITIVI	18-19
PRATI SINTETICI	20
ZERBINI	21-22-23-24-25-26
NASTRI ANTISCIVOLO E BIADESIVI	27
SUGHERO IN ROTOLI E LASTRE	28

CATALOGO



CS008 ANTRACITE



CS007 GRIGIO

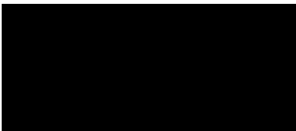

CS009 NERO

BOLFLEX LIGHT

Pavimento vinilico eterogeneo
Superficie a rilievo a bollo

Altezza cm.100 e cm.200

Spessore 1,0 mm.

Peso 1400 gr/mq.

Lunghezza ml.25

Adatto per traffico pedonale
medio/leggero

Reazione al fuoco Bfl-s1

Diametro Bollo mm.25

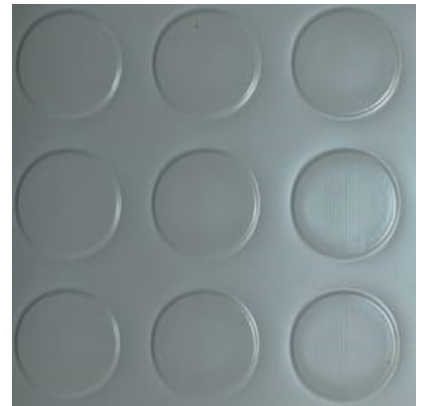

CS001 GIALLO



CS002 VERDE



CS003 BLU



CS004 ROSSO



CS005 MARRONE



CS007 GRIGIO



CS008 ANTRACITE



CS009 NERO

BOLFLEX

Pavimento vinilico eterogeneo
Superficie a rilievo a bollo

Altezza cm.100

Spessore 1,3 mm.

Peso 2000 gr/mq.

Lunghezza ml.25

Adatto per traffico pedonale
medio

Reazione al fuoco Bfl-s1

Diametro Bollo mm.25

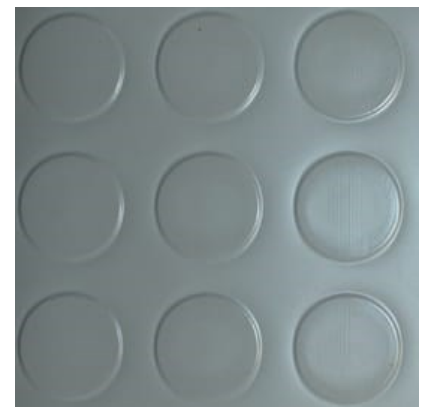



CS007 GRIGIO

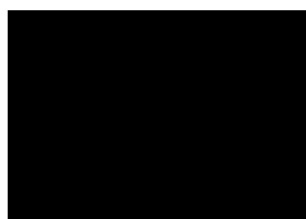

CS009 NERO

MAXI BOLFLEX

Pavimento vinilico eterogeneo

Superficie a rilievo a bollo

Altezza cm.100 e cm.200

Spessore 3,0 mm.

Peso 3900 gr/mq.

Lunghezza ml.15

Adatto per traffico pedonale intenso

Reazione al fuoco Bfl-s1

Diametro Bollo mm.28

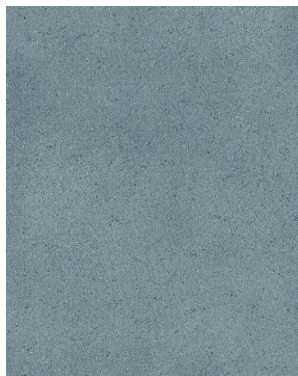
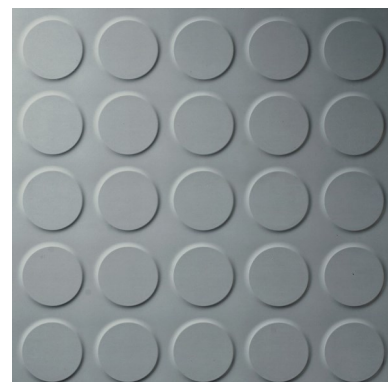

SKY BLUE 573



INK 599

ISAFE R11

Pavimento vinilico eterogeneo antiscivolo R11 con superficie ruvida con granuli di ossido di alluminio

Altezza cm.200

Spessore 2,0 mm.

Peso 2850 gr/mq.

Lunghezza ml.20

Adatto per traffico pedonale intenso

Reazione al fuoco Bfl-s1

Antistatico

Garanzia 5 anni

Superficie Hyperguard+



M.GREY 59



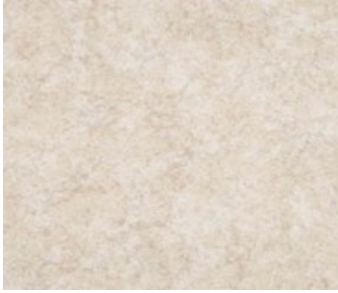

CHATEL 31



CORLEONE 545

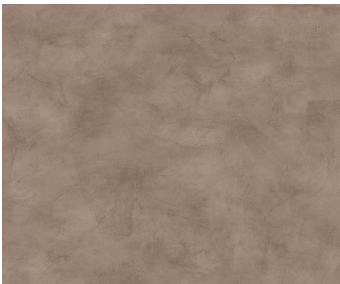

FLORENCE 584



ELDORADO 92

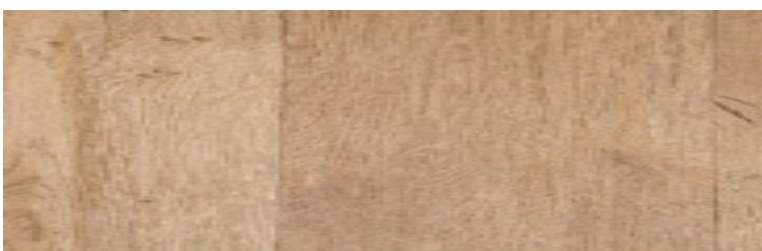

JAKARTA 846

NEW SOLID

Pavimento vinilico eterogeneo
cushionfloor

Altezza cm.200

Spessore 2,0 mm.

Peso 1450 gr/mq.

Lunghezza ml.30

Adatto per traffico pedonale
medio

Reazione al fuoco Bfl-s1

Antiscivolo R10

Classe europea 22

Trattamento superficiale con
Natural Feel

Garanzia 5 anni

Formaldeide E1

Strato d'usura 0,20 mm.



LUBERON 794



ARGENTINA 591



LUBERON 705





27125081 DJ WHITE



27125084 DJ RED



27125083 DJ GREY



RK102

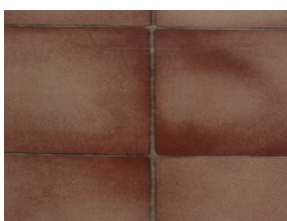

23957

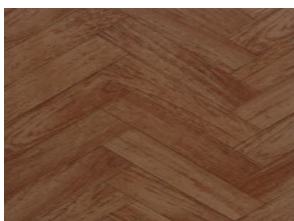

WF14601

ICONIK 260D

Pavimento vinilico eterogeneo

Altezza cm.200

Spessore 2,6 mm.

Peso 1690 gr/mq.

Lunghezza ml.30

Adatto per traffico pedonale
Medio

Reazione al fuoco Bfl-s1

Antiscivolo R10

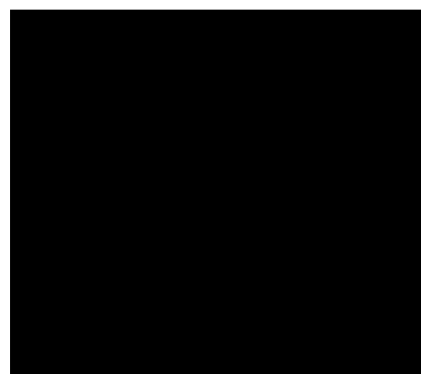

27125082 DJ BLACK



CORALLO

Pavimento vinilico multistrato

Altezza cm.200

Spessore 0,80 mm.

Peso 1250 gr/mq.

Lunghezza ml.40

Adatto per traffico pedonale
leggero

Reazione al fuoco Bfl-s1

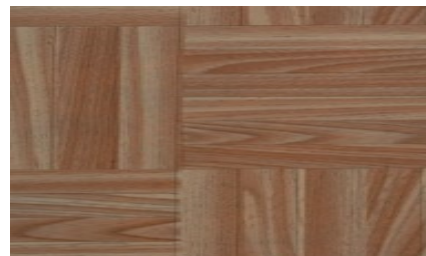

WF18701



WF13007





493



924



913



911



498



921

STANDARD PLUS

Pavimento in vinile omogeneo con disegno passante

Spessore 2,0 mm.

Altezza cm.200 x ml.23

Formati 61x61 cm. X mq.5,20

Peso 3300 gr/mq.

Adatto per traffico pedonale intenso

Reazione al fuoco Cfl-s1

Antiscivolo R10

Antistatico



492



ASPIN 899



SINTRA 583



SAGRES 592



SHALIMAR T82

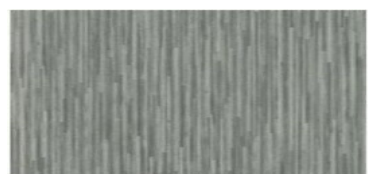

SAGRES 592

SUPERIOR

Pavimento vinilico eterogeneo con superficie x-treme e garanzia di anni 10

Studiato appositamente per ambienti come asili nido, scuole, aree gioco, e tutti gli ambienti frequentati da bambini.

Altezza rotolo cm.200 x ml.30

Spessore 2,8 mm.

Strato d'usura mm.0,20

Isolamento acustico 16 dB

Peso 1600 gr/mq.

Reazione al fuoco Cfl-s1

Antiscivolo DS

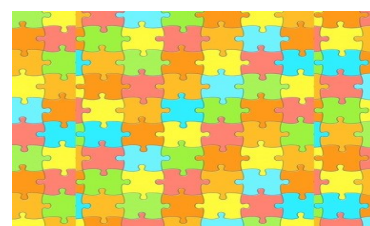

PUZZLE COLOR 50

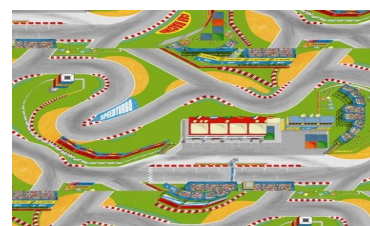

TRAFFIC 50



GRASS 25





REAZIONE AL
FUOCO DI IS1

GOMMA SBR

Pavimento in gomma SBR
100%, con lavorazione a
calandratura, sottofondo
ottimo grip.



Spessore 3,0 mm.

Lunghezza ml.15

Reazione al fuoco: DL Ls1

Resistente a Oli, Grassi,
Idrocarburi e Solventi

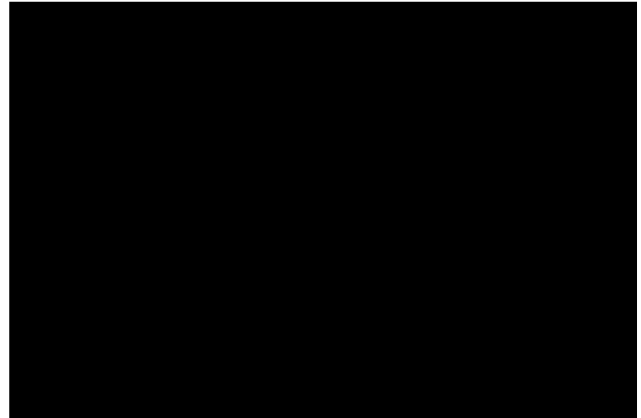

LISCIA Altezza cm.120
Peso 56000 grammi al mq.
Durezza Shore 85 +/-5%

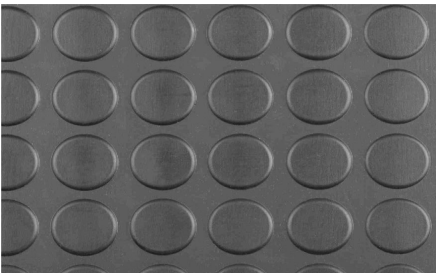

BOLLE Altezza rotolo cm.125
Peso 4950 grammi al mq.
Durezza Shore 80 +/-5%



ALLUMINIO Altezza cm.120
Peso 3700 grammi al mq.
Durezza Shore 80 +/-5%



RIGHE Altezza cm.120
Peso 3700 grammi al mq.
Durezza Shore 65 +/-5%



ARANCIO

SPORT

Pavimento vinilico ad uso
sportivo, costituito da uno
strato di usura in pvc omoge-
neo a superficie goffrata, anti-
sdrucchiolo e antiriflesso, con
supporto in schiuma vinilica e
con interposta una membrana
in fibra di vetro stabilizzante.

Spessore 4,5 mm.

Altezza rotolo cm. 180

Lunghezza max ml.20

Peso kg./mq. 4,5

Reazione al fuoco Bfl-s1



VERDE



AZZURRO



PROROUND

Profilo in pvc di raccordo sanitario con tecnologia BLAH certificata e sistema compound.

Ideale per ambienti sanitari come ospedali, cliniche, laboratori, centri analisi e ovunque vengono richieste prestazioni batteriostatiche.

Barre da cm.270

Esente da piombo, autoestinguente e stabilizzato eco compatibile a base di Sali Ca-Zn.

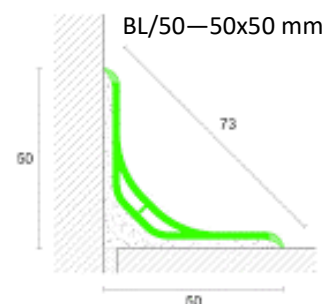
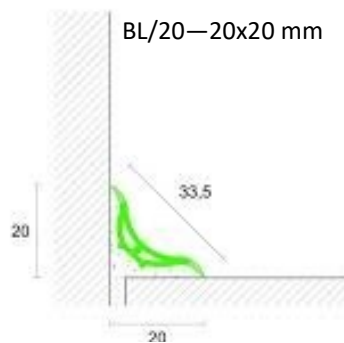

PROROUND ACCESSORI IN ABS



GBL/I20

Angolo Interno 20x20 mm.

GBL/E20

Angolo Esterno 20x20 mm.

GBL/C20

Terminale dx/sx 20x20 mm.

GBL/I50

Angolo Interno 50x50 mm.

GBL/E50

Angolo Esterno 50x50 mm.

GBL/C50

Terminale dx/sx 50x50 mm.

GBL/T50

Angolo Triassiale 50x50 mm.

BATTISCOPA M20

Battiscopa in pvc flessibile sguisciato. Finitura a zero per posa direttamente sul pavimento.

Ideale per ambienti sanitari come ospedali, cliniche, laboratori, centri analisi e ovunque vengono richieste prestazioni batteriostatiche.

Barre da cm.200

Altezza mm.100

Piede mm.30

Spessore mm.3



SGUSCIA M10



Profilo sanitario in pvc flessibile bianco, ideale come base per rivestimenti e pavimenti e ottimo su pavimenti già esistenti, utilizzabile per la messa a norma dei locali soggetti a normative igienico sanitarie.

Barre da cm.200

Misura 20x20 mm.

Ecologico, Ignifugo, Resistente all'acqua e Riciclabile.

20x20

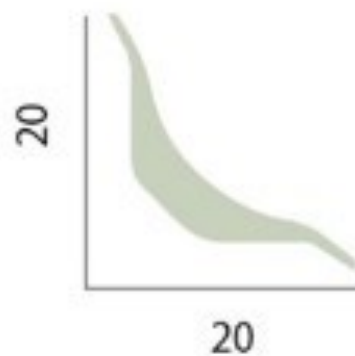

SGUSCIA M08

Profilo sanitario in pvc flessibile bianco, ideale come base per rivestimenti e pavimenti e ottimo su pavimenti già esistenti, utilizzabile per la messa a norma dei locali soggetti a normative igienico sanitarie.

Barre da cm.200

Misura 32x32 mm.

Ecologico, Ignifugo, Resistente all'acqua e Riciclabile.

32x32

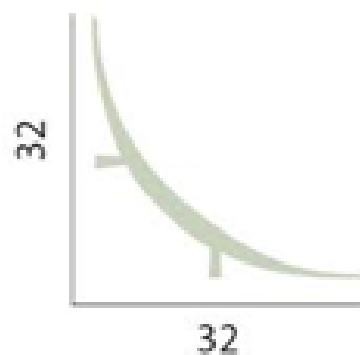



GRIGIO MARRONE NERO

PROTECT 155

Paragradino in pvc flessibile, consigliato per la protezione dei gradini, vengono utilizzati per la messa a norma.

Autoestinguente

Barre da cm.300

Misura 62x39 mm.

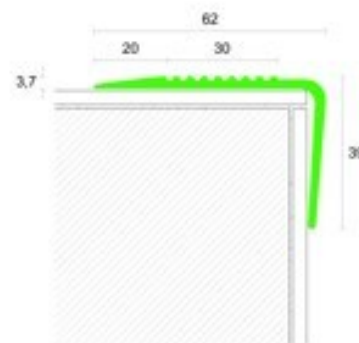

GRIGIO MARRONE NERO

PROTECT 150

Paragradino in pvc flessibile, consigliato per la protezione dei gradini, vengono utilizzati per la messa a norma.

Autoestinguente

Barre da cm.300

Misura 29x24 mm.

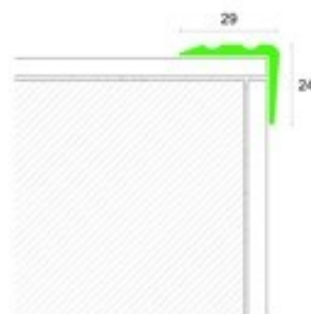

BIANCO NERO



AZZURRO GIALLO



GRIGIO ROSSO



TRASPARENTE

COPRISPIGOLO M12

CoprispigoLO in pvc flessibile assorbimento urti. La camera d'aria e l'angolo arrotondato sono una valida protezione degli spigoli.

Barre da cm.200

Misura 35x35 mm.

Adatto per ambienti come scuole, ospedali, asili, locali pubblici e privati.

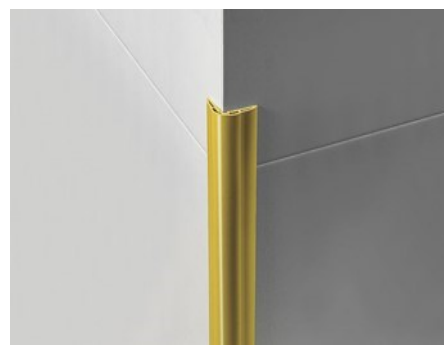
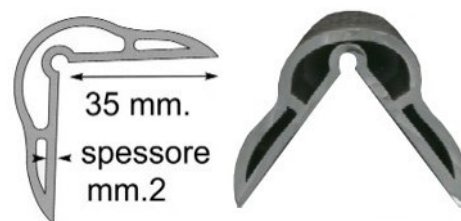



TRASPARENTE



BIANCO

PARASPIGOLO R10

Paraspigolo in pvc rigido estremamente resistente, ideale per ambienti commerciali e industriali.

Ignifugo, Resistente all'acqua e Riciclabile.

Barre da cm.300

Misura 50x50 mm.

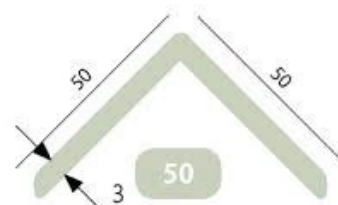

PARASPIGOLO PVC LINE

Paraspigolo in pvc espanso, ideale per ambienti civili, commerciali ed industriali, Autoestingente

Barre da cm.300

mm.24x24

mm.30x30

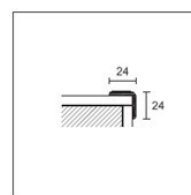

8610

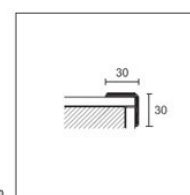

8611



555 BIANCO



557 NERO



556 GRIGIO



558 ANTRACITE

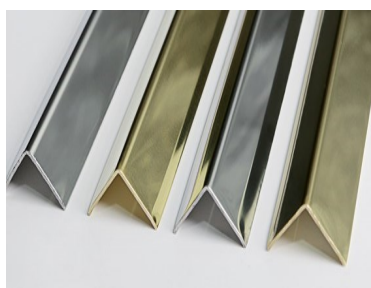

PARASPIGOLO N4

Paraspigolo in pvc espanso laccato, ideale per ambienti civili e commerciali.

Ignifugo, Resistente all'acqua e Riciclabile

Barre da cm.300

Misura 30x30 mm.



ORO OPACO



ORO LUCIDO



ARGENTO OPACO



ARGENTO LUCIDO



BATTISCOPIA PVC LINE 8600

Battiscopa in pvc espanso semi flessibile ideale per ambienti civili e commerciali, autoestinguente.

Barre da cm.200

Altezza mm.70

Piede mm.10

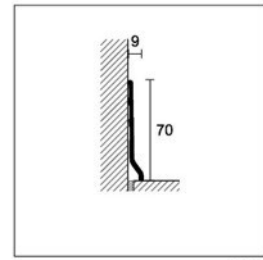

8600



555 BIANCO



557 NERO



556 GRIGIO



558 ANTRACITE

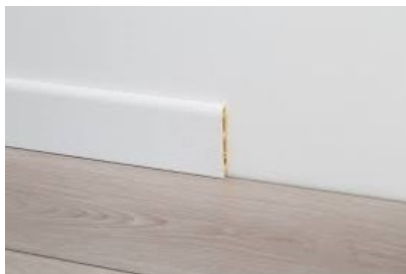

BATTISCOPIA PVC LINE 8605

Battiscopa in pvc espanso rivestito con pellicola PDS, molto resistente ideale per ambienti civili, sportivi, commerciali ed industriali

Autoestinguente

Barre da cm.250

Altezza mm.70

Spessore mm.10

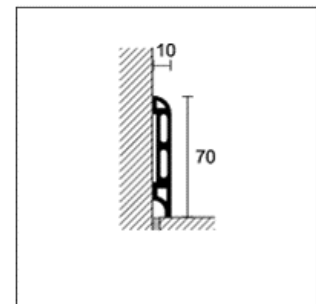

8605



98 ARGENTO



96 BIANCO



97 NERO



BATTISCOPIA 8612/10

Battiscopa in pvc espanso rivestito con pellicola PDS adatto per ambienti civili e commerciali

Autoestinguente

Altezza mm.45 x 10

Barre da cm.250

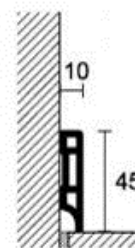

96 BIANCO



NERO



BIANCO

PROFILO M34

Profilo in pvc flessibile per la rifinitura dei rivestimenti murali, adatto per uso civile, sportivo e commerciale.

Ignifugo, Resistente all'acqua e Riciclabile.

Barre da cm.200

Altezza mm.20

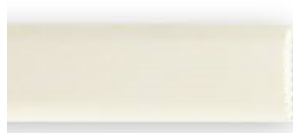
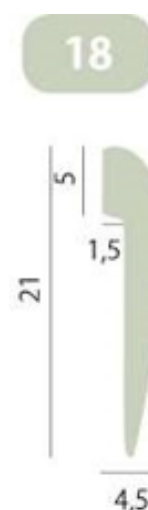

BIANCO



NERO

ASTA Z4

Bacchetta in pvc espanso per uso civile e commerciale,

Ignifugo, Resistente all'acqua e Riciclabile.

Barre da cm.200

Altezza mm.20 x2



BATTISCOPA M01

Battiscopa in pvc flessibile per uso sportivo, civile, commerciale ed industriale.

Ignifugo, Resistente all'acqua e Riciclabile.

Altezza cm.7 - Spess.1,8 mm.

Piedino 15 mm. - Rotoli ml.50

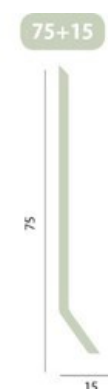

BIANCO



NERO



GRIGIO



MARRONE



ROSSO



VERDE



BLU



BIANCO



NERO



GRIGIO



BLU

PARACOLPO M38

Fascia paracolpi in pvc flessibile per uso murale, adatto per uso civile, sportivo, commerciale ed industriale.

Ignifugo, Resistente all'acqua e Riciclabile.

Altezza mm.200

Spessore 3,5 mm.

Rotoli da ml.20

200 MM



3,5

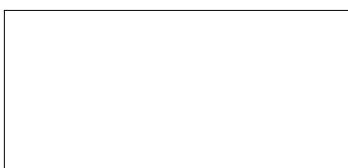

BIANCO

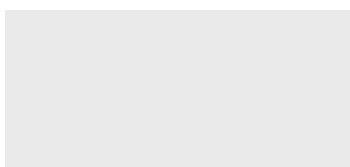

CENERE

PVC LINE 148 C+BR

Profilo di rifinitura in pvc accoppiato per rivestimenti murali. Permette di rifinire esteticamente e ricoprire le estremità dei rivestimenti.

Barre da cm.300

Altezza mm.28



BIANCO



FUME'



TRASPARENTE

SALVAPARETE 1B

Salva parete protezione muri, in materiale plastico con fori e viti/tasselli, per uso civile e commerciale.

Formato cm.80 x 8

Spessore 4 mm.





PROSTAIR 150

Tondino in alluminio oro brillantato con tappi finali in ottone lucido.

Adatto per passatoie tessili sui gradini

mm.11 x cm.80
mm.11 x cm.90
mm.11 x cm.100
mm.11 x cm.120
mm.13 x cm.80
mm.13 x cm.100



PROSTAIR 170

Occhiolo in ottone pieno lucido con vite in acciaio inox per tondini da mm.11 e mm.13

mm.11
mm.13



PROSTAIR 174

Cerniera in ottone pieno lucido per tondini da 11 mm.

mm.11



ARGENTO



ORO

PROTECT 476/CV

Paragradino antiscivolo in alluminio anodizzato con fori e viti/tasselli. Inserto al carborundum attivo.

Cm. 113
Cm. 340

Conforme alla normativa DIN1131 in materia di gradino antiscivolo.

Misura mm. 52x30



PROLOCK 485/AD

Profilo in alluminio argento autoadesivo con funzione terminale di moquette

Cm. 93

Misura 26x12,5 mm.



PROCLASSIC_4020/AD

Profilo di rifinitura in ottone lucido autoadesivo per raccordare pavimenti di pari livello.

Larghezza mm. 30

Cm. 103

Cm. 166

Cm. 270



PROCLASSIC 4720/AD

Profilo di rifinitura in acciaio lucido autoadesivo per raccordare pavimenti di pari livello.

Larghezza mm. 30

Cm. 103

Cm. 166

Cm. 270



PROCLASSIC 4020/CV

Profilo di rifinitura in ottone lucido con fori per raccordare pavimenti di pari livello.

Larghezza mm. 30

Cm. 103

Cm. 166

Cm. 270



PROCLASSIC 4720/CV

Profilo di rifinitura in acciaio lucido con fori per raccordare pavimenti di pari livello.

Larghezza mm. 30

Cm. 103

Cm. 166

Cm. 270



PROLEVEL MEDIUM 46/AD

Profilo di rifinitura in alluminio argento adesivo per raccordare pavimenti con dislivello massimo di 5,5 mm.

Cm. 93

Cm. 166

Misure mm.28x5,5



PROCLASSIC 430/AD

Profilo di rifinitura in alluminio argento adesivo per raccordare pavimenti di pari livello

Larghezza mm.30

Cm. 93

Cm. 166

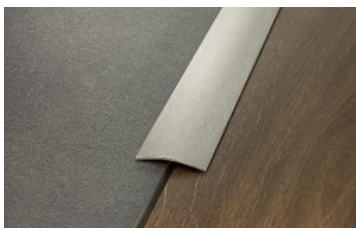

PROCLASSIC 4722/AD

Profilo di rifinitura in acciaio satinato adesivo per raccordare pavimenti di pari livello.

Larghezza mm. 30

Cm. 93

Cm. 270



PROLEVEL HIGH 4711/AD

Profilo di rifinitura in acciaio lucido adesivo per raccordare pavimenti con dislivelli da 7 a 12 mm.

Cm. 93

Cm.166

Larghezza mm.38

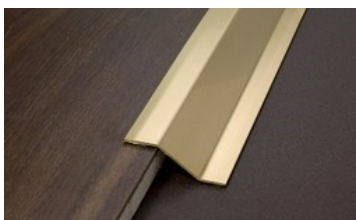

PROLEVEL HIGH 4311/AD

Profilo di rifinitura in ottone lucido adesivo per raccordare pavimenti con dislivelli da 7 a 12 mm.

Cm. 93

Cm.166

Larghezza mm.38



PROTECT 470/AD

Paragradino in alluminio argento autoadesivo per la protezione dei gradini.

Conforme alla normativa DIN 51131 in materia di gradini antiscivolo.

Misura mm.42x25

Cm. 113

Cm. 166



PROCORNER 777/A

Paraspigolo in acciaio inox lucido autoadesivo per uso professionale.

Conforme alle normative igienico sanitarie AISI 430 DIN 1,4016

Misura 30x30 mm.

Cm. 300

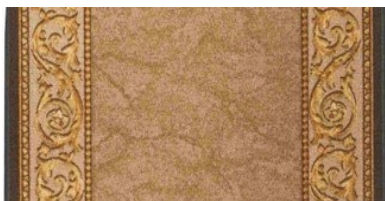

BEIGE



ROSSO



VERDE

CORDOBA

Corsia tessile con superficie bouclè con bordatura a filato sui lati lunghi. Sottofondo in gomma antiscivolo. 100% Poliammide.

Indicato per uso civile e commerciale con traffico pedonale medio.

Altezza cm.67

Lunghezza rotoli ml.30

Peso 1300 gr/mq.

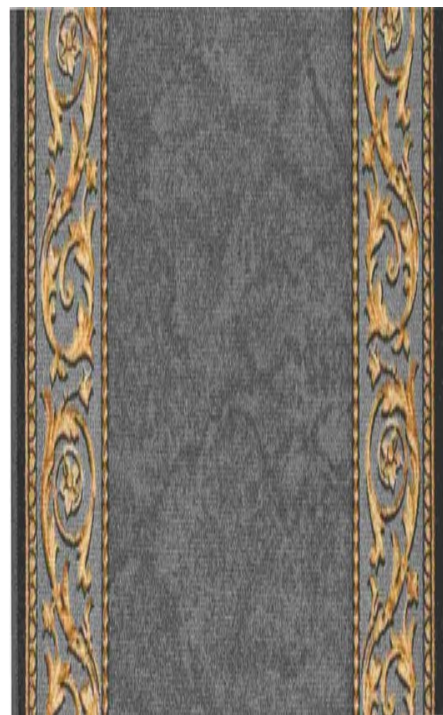

GRIGIO

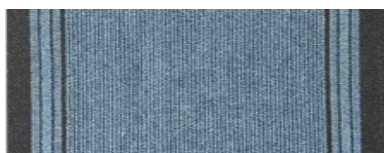

BLU

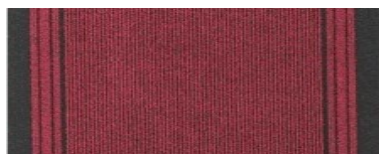

ROSSO



MARRONE

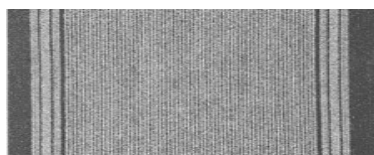

GRIGIO

CORRIDOR

Corsia tessile con superficie rasata con sottofondo in lattice, 100% Poliammide

Indicato per uso civile e commerciale con traffico pedonale medio.

Altezza cm.67

Rotoli lunghezza ml.30

Peso 1100 gr/mq.



BEIGE



PRIMER AC PLUS

Promotore di adesione per tutti i sottofondi assorbenti.

Consumo 100/300 gr/mq.

Conf. 5 kg.

Conf. 10 kg.



ECOGRIP

Promotore di adesione per sottofondi non assorbenti.

Consumo 100/200 gr/mq.

Conf. 10 kg.



RASOPAST 105

Rasatura in pasta pronta per tutti i sottofondi

Consumo 1,2 kg/mm spessore

Conf. 5 kg.

Conf. 15 kg.



LIVELLANTE 140 S

Rasatura in polvere a grana fine per sottofondi assorbenti

Consumo 1,2 kg/mm spessore

Conf. 25 kg.



LIVELLANTE 140 M

Rasatura in polvere grana media per sottofondi assorbenti

Consumo 1,4 kg/mm spessore

Conf. 25 kg.



ULTRADUR

Autolivellante in polvere ad asciugatura rapida

Consumo 1,6 kg/mm spessore

Conf. 25 kg.



DETERGENTI

FLOOR DAY Detergente neutro per tutti i pavimenti

Flacone 1 litro

FLOOR CLEAN Detergente decerante per tutti i pavimenti

Flacone 1 litro

FLOOR SHINE Cera metallizzata per tutti i pavimenti

Flacone 1 litro



HYCOL KD UNIVERSAL

Collante acrilico per pavimenti e rivestimenti vinilici, gomma, pvc e moquettes all'interno e su sottofondi assorbenti e non assorbenti.

Consumo 300/400 gr/mq.

Conf. 1 kg.

Conf. 5 kg.

Conf. 18 kg.



HYCOROLL

Collante acrilico per pavimenti vinilici e moquettes all'interno su sottofondi assorbenti e non

Consumo 250/400 gr/mq.

Conf. 5 kg.

Conf. 24kg.



GOMMAPUR

Collante bicomponente poliuretano per pavimenti e rivestimenti vinilici e gomma su sottofondi assorbenti e non assorbenti anche all'esterno.

Consumo 500/1000 gr/mq.

Conf. 10 kg.



SIPOL PLUS

Collante bicomponente eposipoliuretano per pavimenti in legno di qualsiasi tipo e modello su sottofondi assorbenti e non assorbenti.

Consumo 1000/1500 gr/mq.

Conf. 10 kg.



TAK 02

Adesivo polifunzionale in cartuccia universale per profili in pvc, marmo, legno, gomma,

Cartuccia ml.280





EXTERIOR

Prato sintetico in fibra 100% polipropilene con lavorazione a tufting, supporto di coesione in lattice drenante, adatto al traffico pedonale medio, per interni ed esterni

Altezza cm.100 e cm. 200

Rotoli ml. 25 - Spessore 7 mm.

Peso 1005 gr/mq.

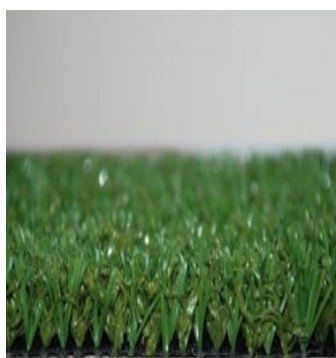

ASCOT

Prato sintetico in fibra 100% polipropilene con lavorazione a tufting, supporto di coesione in lattice drenante, adatto al traffico pedonale intenso, per interni ed esterni

Altezza cm.200

Rotoli ml.10 - Spessore 16 mm

Peso 1800 gr/mq.

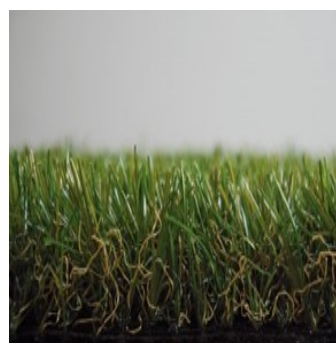

SAVANA

Prato sintetico in fibra 100% polipropilene con lavorazione a tufting, supporto di coesione in lattice drenante, adatto al traffico pedonale intenso, per interni ed esterni

Altezza cm.200

Rotoli ml.25 - Spessore 20 mm

Peso 2500 gr/mq

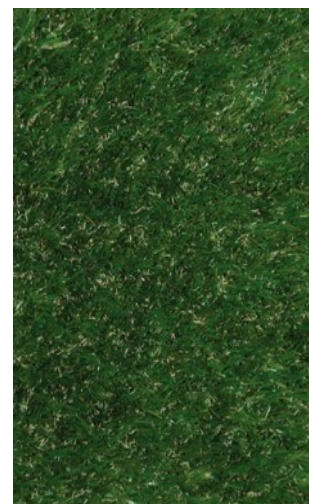



GREGGIO

VELCOC

Zerbino in fibra di cocco naturale al 100% e sottofondo in pvc, adatto per ambienti all'interno e all'esterno.

Classe di reazione al fuoco C2

Spessore 17 mm. Kg/mq. 6,21

Spessore 23 mm. Kg/mq. 7,10

Spessore 30 mm. Kg/mq. 10,0

Spessore 17 mm. Kg/mq. 5,80

Rotoli lunghezza massima 10 metri lineari. Altezza cm. 100 e cm. 200 per il Greggio e Altezza cm.100 per i colorati.

Greggio

Greggio

Greggio

Colorato

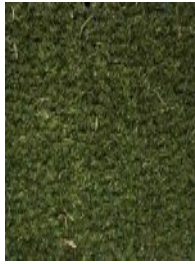

VERDE



BLU



GRIGIO

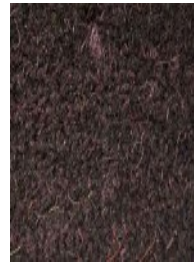

MARRONE



ROSSO

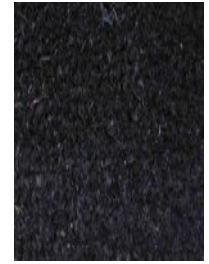

NERO



BEIGE

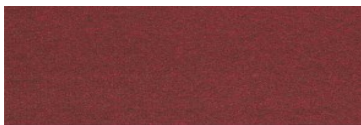

ROSSO



GRIGIO

DAKOTA

Tappeto asciugapasso in fibra sintetica, sottofondo in vinile, per interni ed esterni.

100% Polipropilene

Lavorazione a tuftato

Bordo in gomma sui lati lunghi

Spessore 5 mm.

Peso 2300 gr/mq.

Altezza cm.90

Rotoli lunghezza ml.15

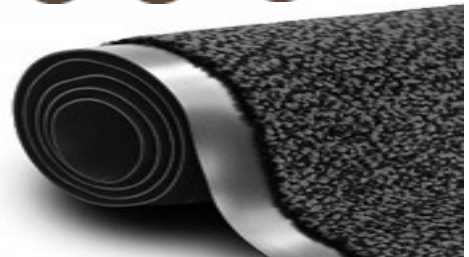



338 GREGGIO

ZERMAT 4220

Zerbino in fibra sintetica agugliato velluto dilour, sottofondo in gomma antiscivolo, per interni ed esterni.

Rotoli da ml.20

Spessore 9 mm.

Peso 2500 gr/mq.

Altezza cm.200



609 ELETTRICO

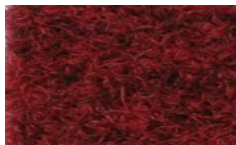

181 BORDEAUX

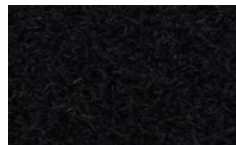

345 NERO



348 FIAMMA

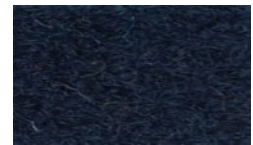

638 TOPO

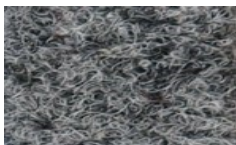

561 GRIGIO

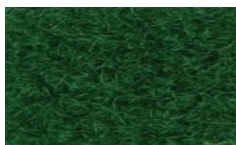

574 PRATO

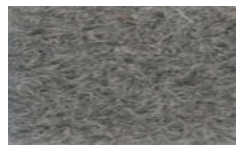

607 CENERE

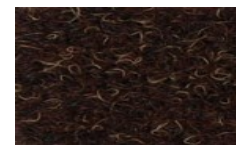

612 CASTAGNA

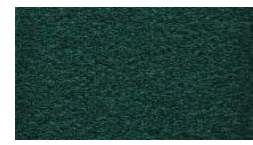

485 VERDONE



VERDE

SUPER RALLY

Zerbino in filamento di pvc drenante, per interni ed esterni, ottimo nel settore nautico.

Rotoli da ml.6

Spessore 14 mm.

Peso 5760 gr/mq.

Altezza cm.120



GRIGIO

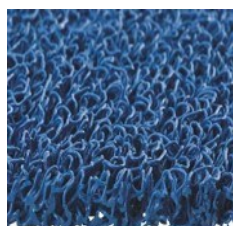

BLU

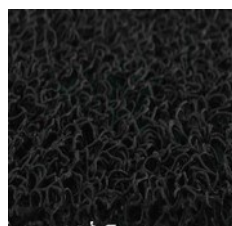

NERO



ROSSO



MARRONE

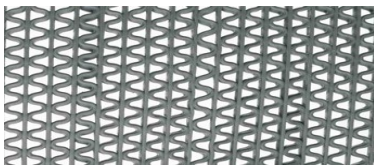

GRIGIO

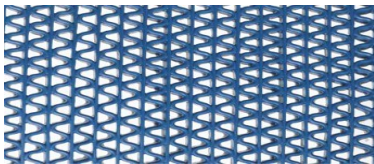

BLU

ZIG-ZAG

Tappeto in pvc drenante per interni ed esterni, ottimo nel settore nautico e piscine.

Altezza cm.120

Spessore 5 mm.

Peso 4700 gr/mq.

Rotoli da ml.15



TURF

Zerbino in pvc drenante, per interni ed esterni, ottimo potere defangatoio.

Altezza cm.110

Spessore 15 mm.

Peso 2850 gr/mq.

Rotoli da ml.15

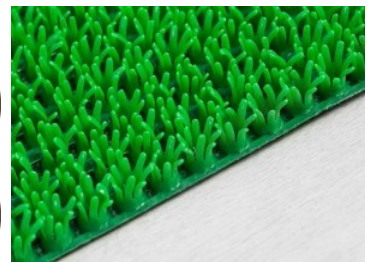

338 GREGGIO

ZERMAT 800

Zerbino sintetico in polipropilene, sottofondo in gomma antiscivolo, per interni ed esterni.

Altezza cm.100

Spessore 9,0 mm.

Peso 2500 gr/mq.

Rotoli da ml.20



181 ROSSO



345 NERO



561 GRIGIO



BLU

COSTA 2

Zerbino sintetico in polipropilene, sottofondo in lattice di gomma antiscivolo, per interni ed esterni.

Altezza cm.200

Spessore 8 mm.

Peso 1950 gr/mq.

Lunghezza ml. 25



ANTRACITE



GRIGIO

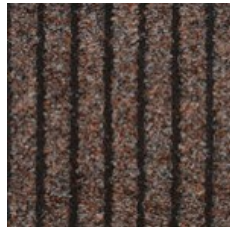

MARRONE

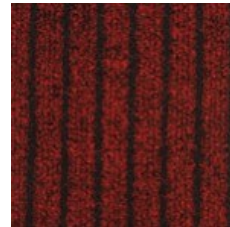

ROSSO



VERDE



GRIGIO

ALASKA

Tappeto asciugapasso in fibra sintetica, sottofondo in vinile, per interni ed esterni.

100% Polipropilene

Lavorazione a taftato

Bordo in gomma sui lati lunghi

Spessore 5,0 mm.

Peso 2300 gr/mq.

Altezza cm.90

Rotoli lunghezza ml.15

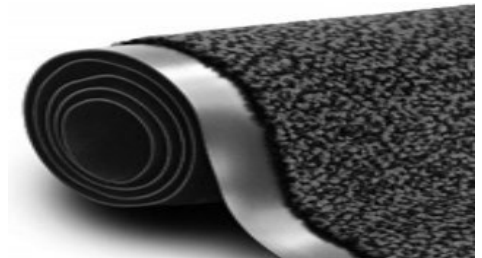

ROSSO



BEIGE

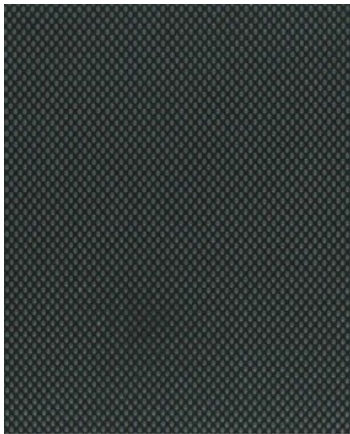

ROLLER

Zerbino in gomma 100% con superficie pedunculata, per interni ed esterni.

Altezza cm.100

Spessore 12 mm.

Peso 9000 gr/mq.

Lunghezza ml.10



WAVES

Zerbino in gomma 100%, per interni ed esterni, antiscivolo.

Formato 90x150 cm.

Spessore 15 mm.



Superficie super pulente

Disegno onda



BUBBLE

Zerbino in gomma 100%, per interni ed esterni, antiscivolo.

Formato 90x120 cm.

Spessore 15 mm.



Superficie super pulente

Disegno semisfera

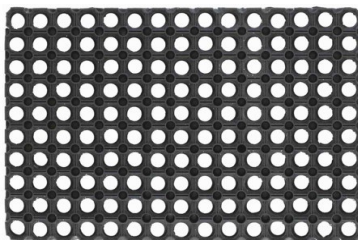

GUMMY

Zerbino in gomma 100%, per interni ed esterni, antiscivolo, componibile.

Formato:

Cm. 50x100

Peso 4,7 kg.

Cm. 100x150

Peso 14 kg.



GIUNTI GUMMY

Speciale giunzione in gomma per zerbino gummy

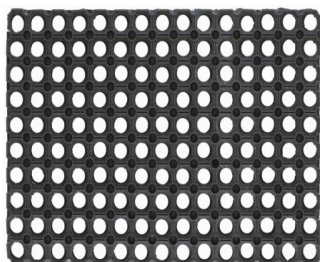

GUMMY ROTOLO

Tappeto in gomma 100%, per interni ed esterni, drenante defangatoio.

Rotolo Altezza cm.100

Spessore 22 mm.

Peso 7200 grammi

Lunghezza ml.7,5

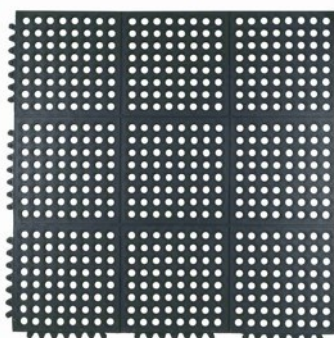

RESTAURANT MAT

Tappeto in gomma 100% componibile, studiato appositamente per cucine, officine, laboratori ed ambienti con umidità a pavimento.

Spessore 14 mm.

Formato 91x91 cm.

Peso 5500 grammi



RETE ANTISCIVOLO TAPPETI

Rete antiscivolo sotto tappeti

Blister e Rotolo

Formato cm. 60x120

Formato cm. 80x150

Formato cm. 120x180

Formato cm. 160x224

Rotoli altezza cm.150





Colore Nero

ANTISLIP

Nastro antiscivolo formato da un rivestimento uniforme di grana abrasiva depositata su uno strato polimerico.

Colore Nero

Larghezza mm.19 ml.18

Larghezza mm.25 ml.18

Larghezza mm.50 ml.18



Colore Bianco

Nastro di eccezionale qualità, resistente a temperature che variano da -30°/+110°.

Colore Bianco

Larghezza mm.25 ml.18



Colore Grigio/Giallo

Indicato per tutte le superfici scivolose o pericolose come scale, gradini, passerelle, ecc.

Colore Nero/Giallo

Larghezza mm.25 ml.18



Fosforescente

Fosforescente

Larghezza mm.25 ml.15



DOUBLE POLYP

Nastro biadesivo in PLP per la posa di moquette, pavimenti vinilici, corsie e passatoie.

Lunghezza ml.5

Lunghezza ml.25

Rotoli larghezza mm.50

Spessore 115 my

DOUBLE NET

Nastro biadesivo in garza molto forte per la posa di moquette, pavimenti vinilici, corsie e passatoie.

Lunghezza ml.5

Lunghezza ml.25

Rotoli larghezza mm.50

Spessore 200 my



ISOCORK/450

Lastra in agglomerato di sughero naturale al 100%, per arredamento ed isolamento termo acustico.



Formato 925x615 mm.

Superficie levigata

Densità kg. 220 al mc

Resistenza compressione 45%

Riduzione acustica 26 dB

Tensione di rottura 400 kPa

Spessore 2 mm.

Spessore 3 mm.

Spessore 4 mm.

Spessore 5 mm.

Spessore 6 mm.

Spessore 10 mm.

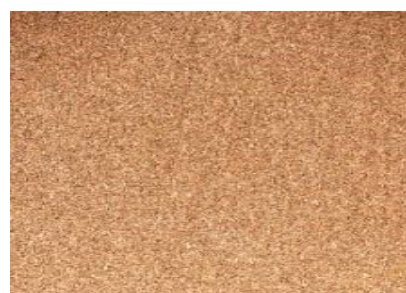

ISOCORK/453

Rotolo in agglomerato di sughero naturale al 100%, per arredamento ed isolamento termo acustico.



Rotoli Altezza cm.100

Lunghezza ml.30

Densità kg. 190 al mc.

Resistenza compressione 35%

Riduzione acustica 16 dB

Tensione di rottura 400 kPa

Spessore 2 mm.

Spessore 3 mm.

Spessore 5 mm.



